

Boletim Técnico #25

Errata do BT04 - Projeto trilho embutido - Sistema Produtiva, Gold Slim e Nova Gold



Atualizações técnicas:

Conceitual	Pág 02
Aplicação no sistema Produtiva	Pág 03
Aplicação no sistema Gold Slim	Pág 06
Aplicação no sistema Nova Gold	Pág 09
Mapa de perfis	Pág 12

Conceitual

Trilho embutido para manter piso interno e piso externo com mesmo nível, sem tropeço.

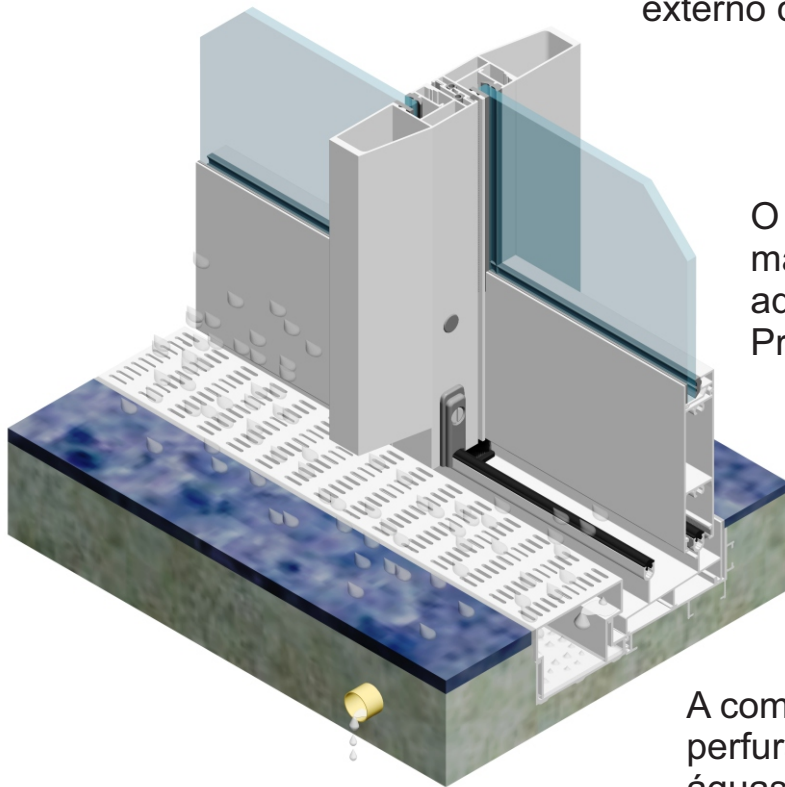

O sistema conta com perfis de contra marco, calhas, presilhas e arremtes que se adaptam a diversas tipologias dos sistemas Produtiva, Gold Slim e Nova Gold.

A composição dos perfis calha e tampa com perfurações, garantem a captação de águas pluviais e drenagem no sistema.

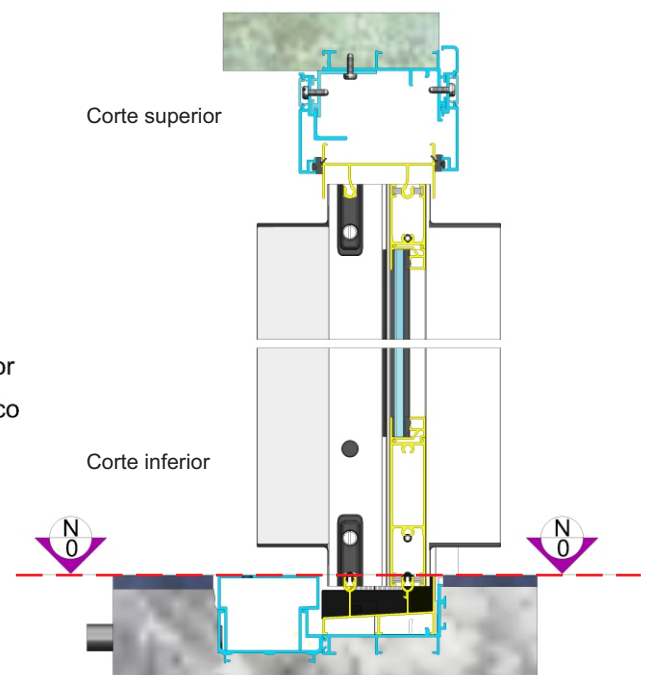
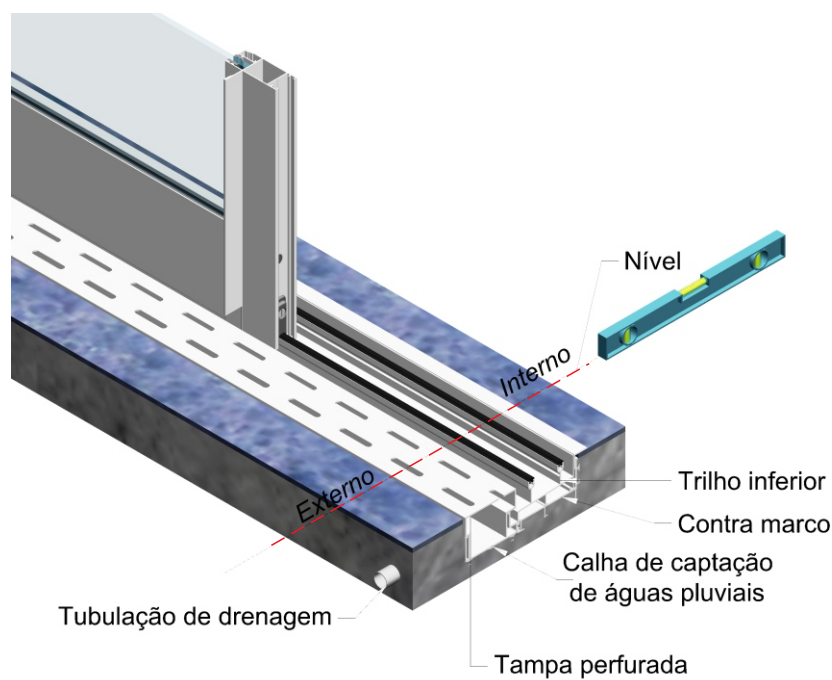

Aplicação no sistema Produtiva.....

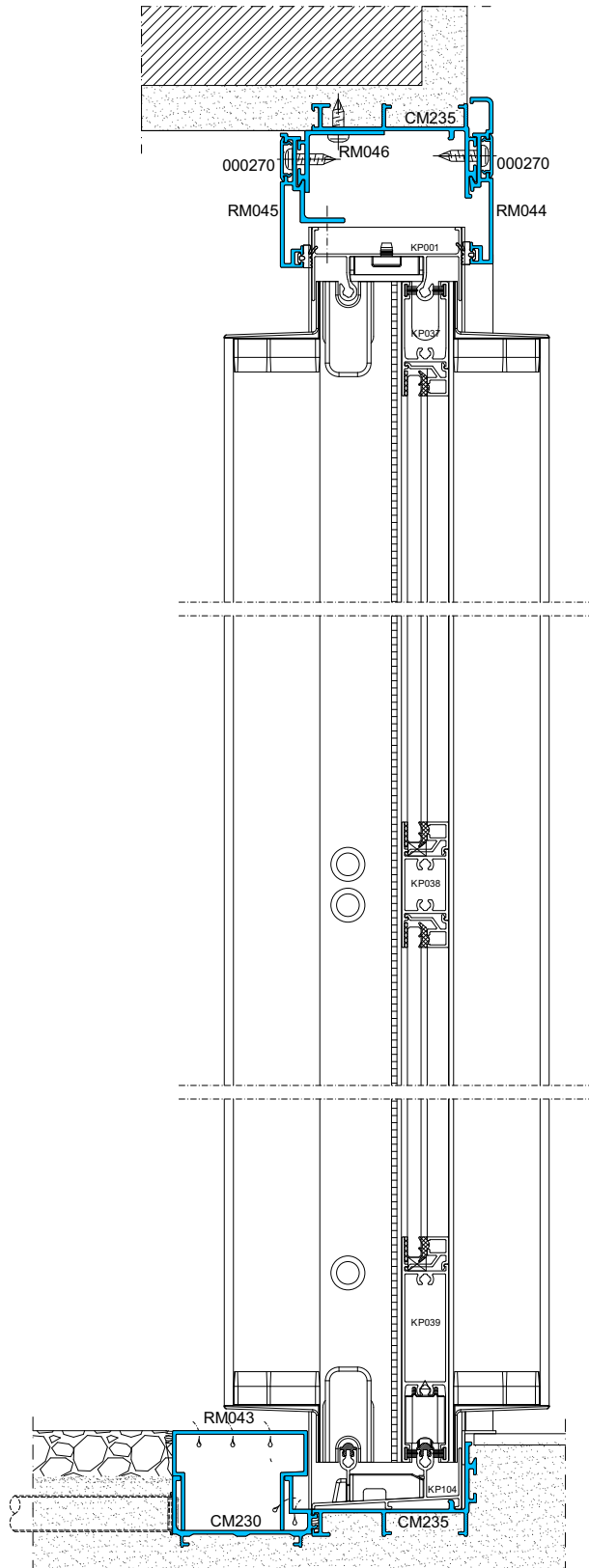

TIPOLOGIAS

Portas de Correr 2 e 4 folhas 2 planos

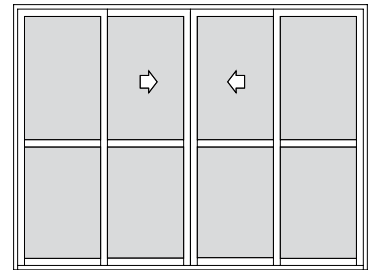
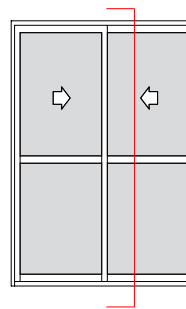

Aplicação no sistema Produtiva.....

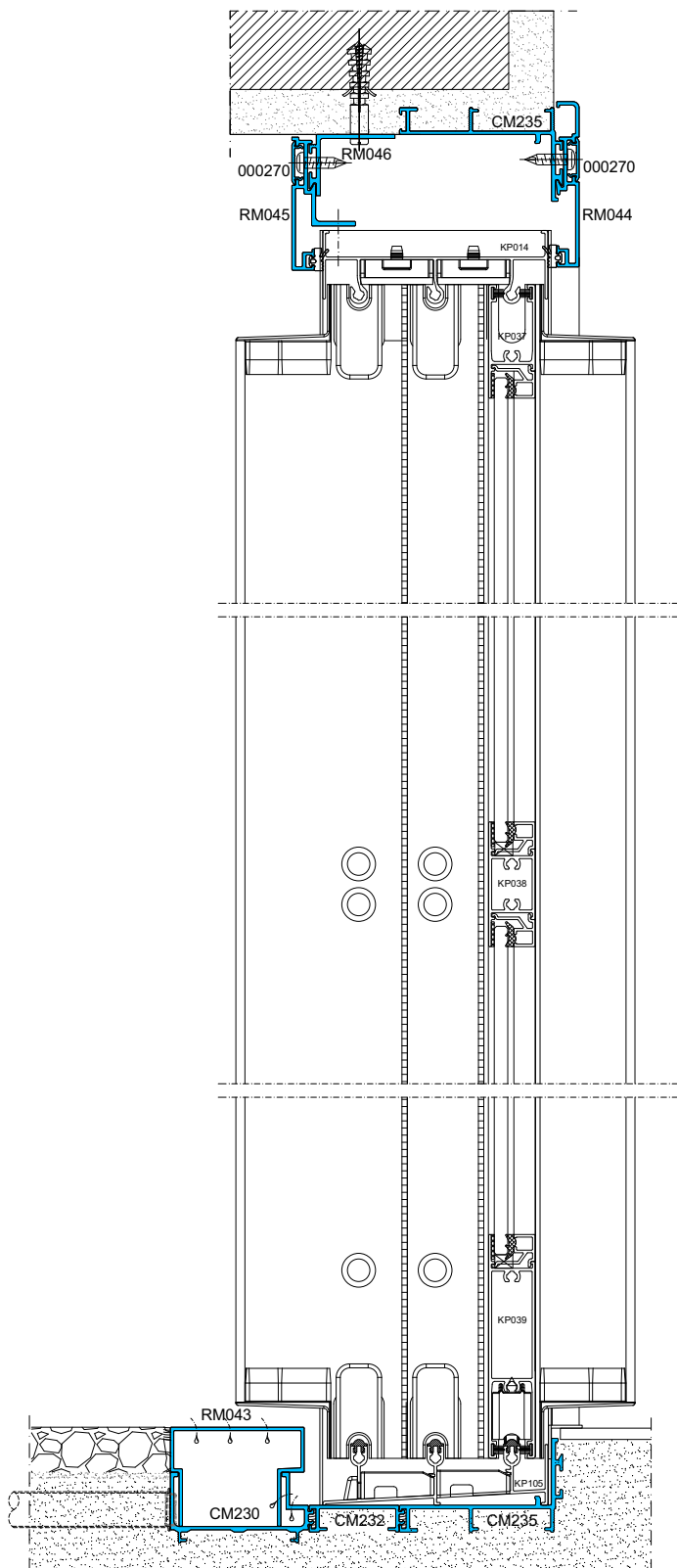

TIPOLOGIAS

Portas de Correr 3 folhas 3 planos

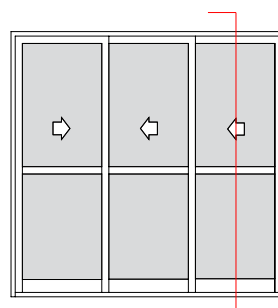

Aplicação no sistema Produtiva.....

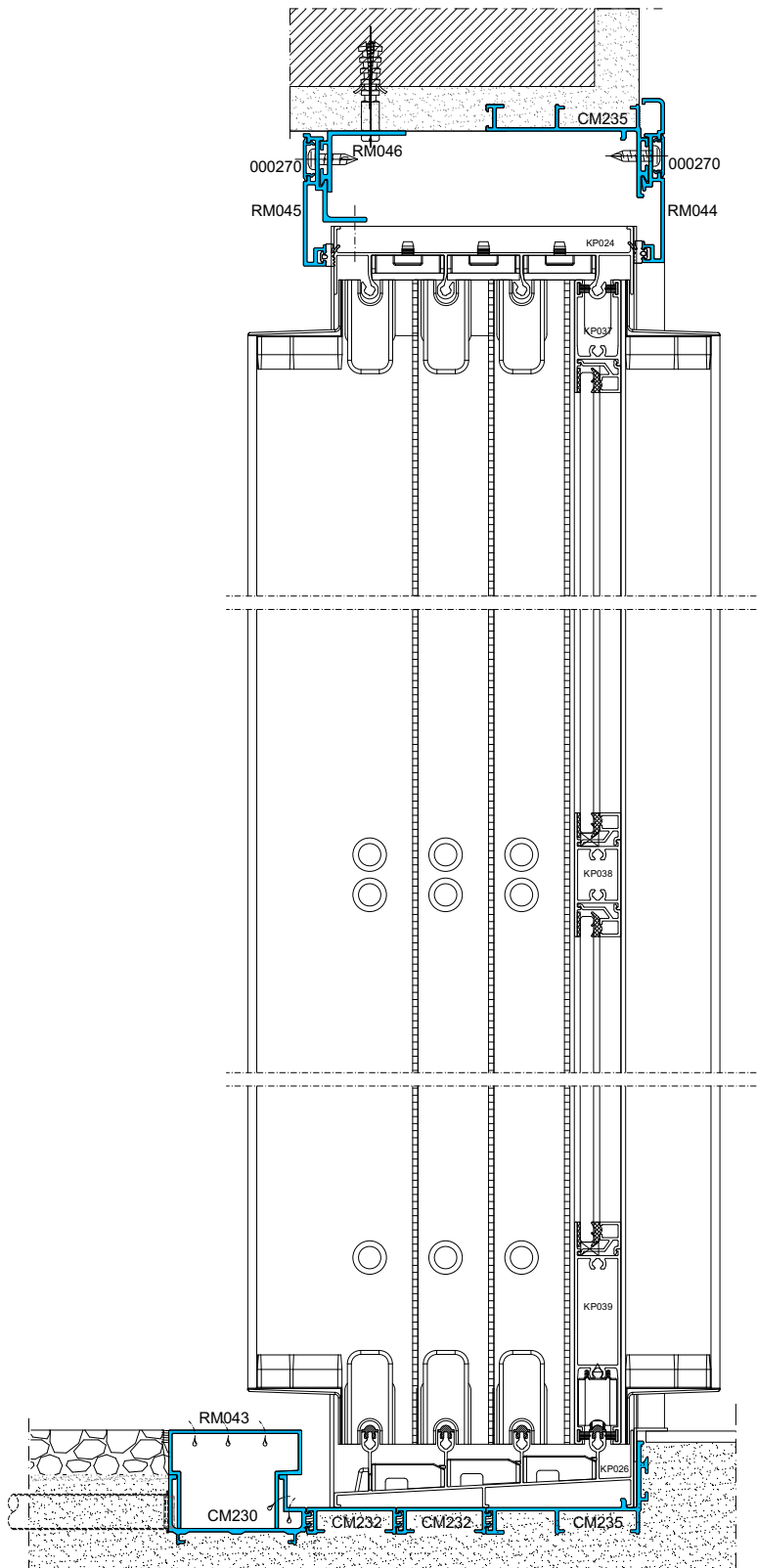

TIPOLOGIAS

Portas de Correr 4 folhas 4 planos

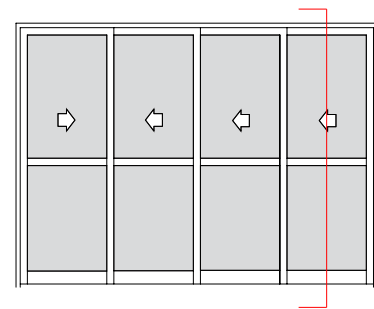

Aplicação no sistema Gold Slim.....**GOLD Slim**

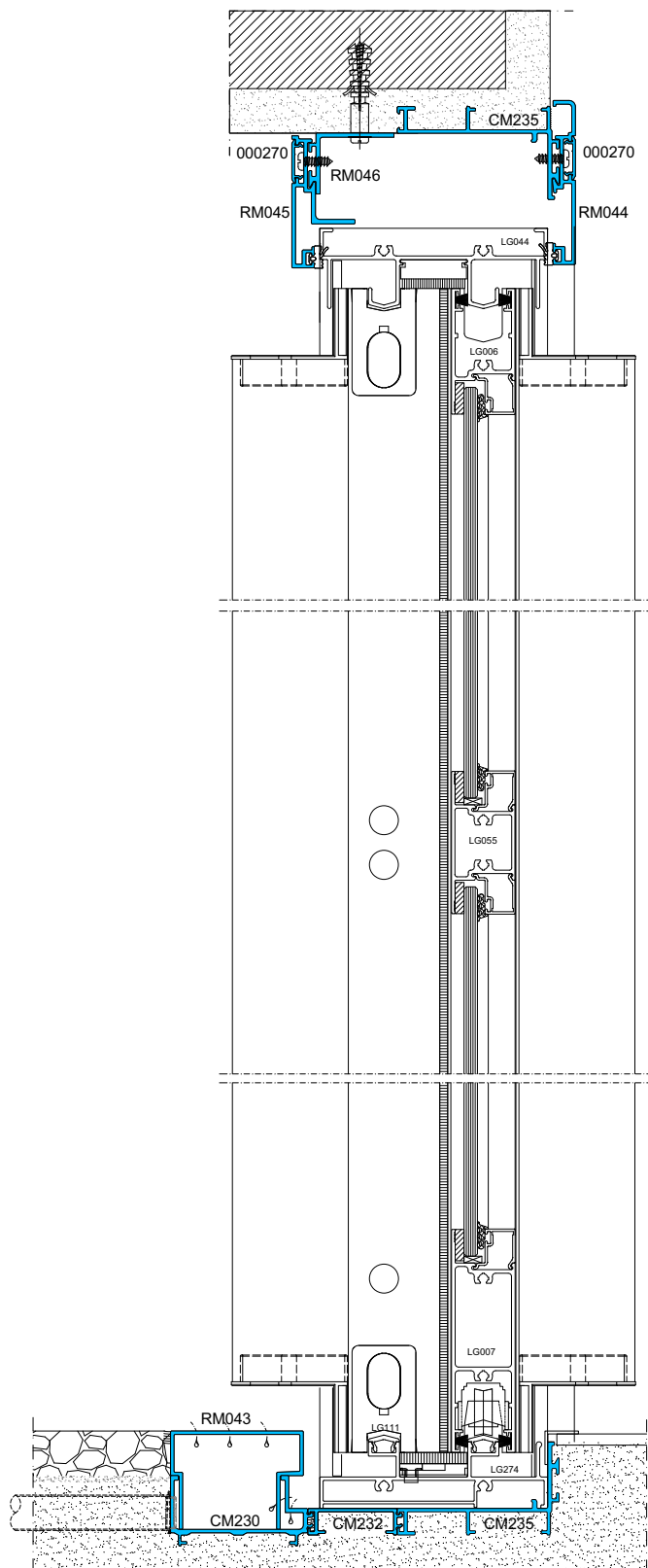

TIPOLOGIAS

Portas de Correr 2 e 4 folhas 2 planos

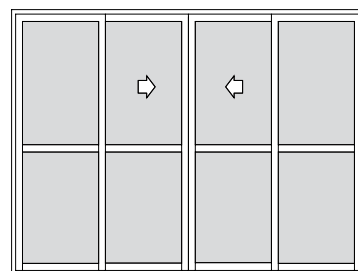
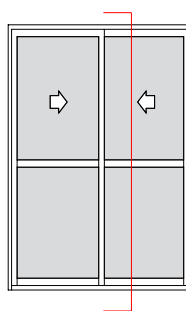

Aplicação no sistema Gold Slim.....**GOLD Slim**

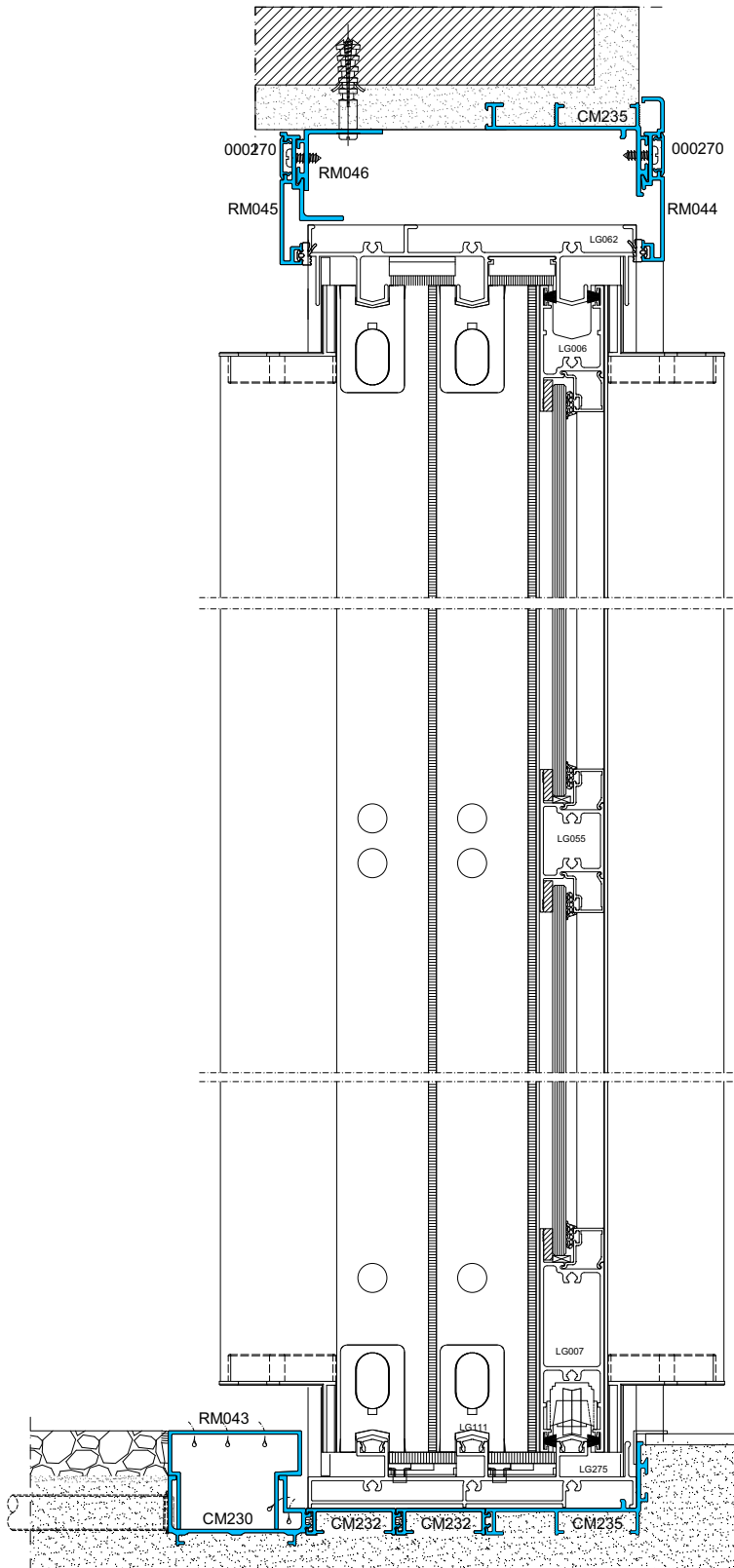

TIPOLOGIAS

Portas de Correr 3 folhas 3 planos

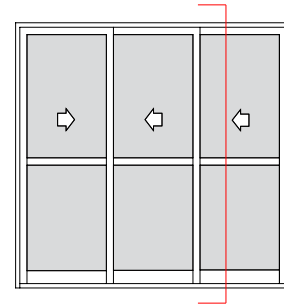

Aplicação no sistema Gold Slim.....**GOLD Slim**

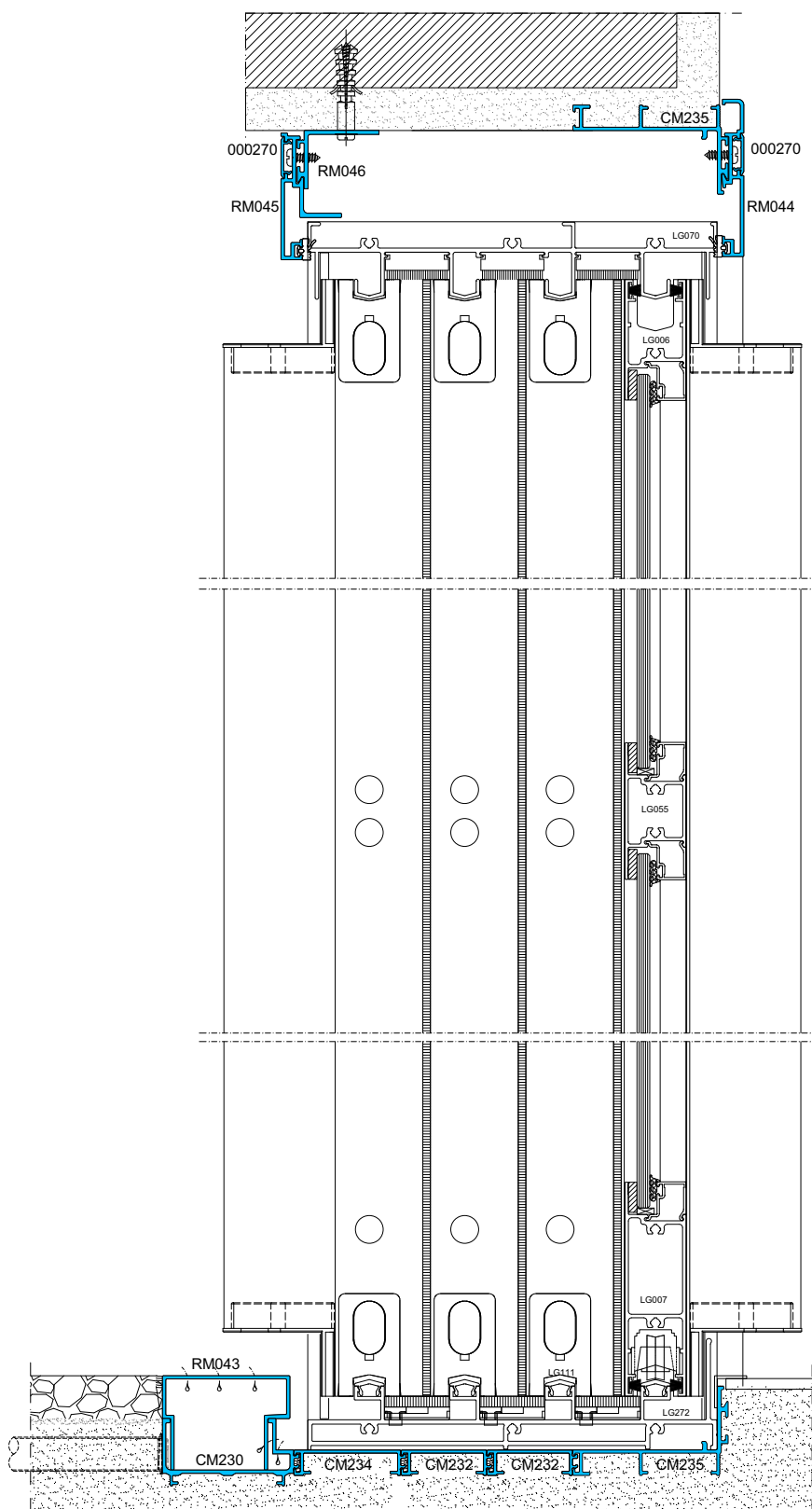

TIPOLOGIAS

Portas de Correr 4 folhas 4 planos

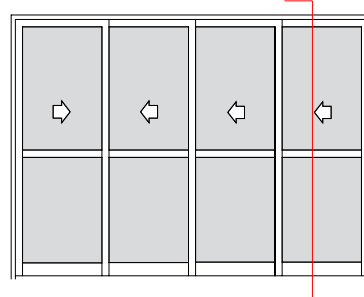

Aplicação no sistema Nova Gold

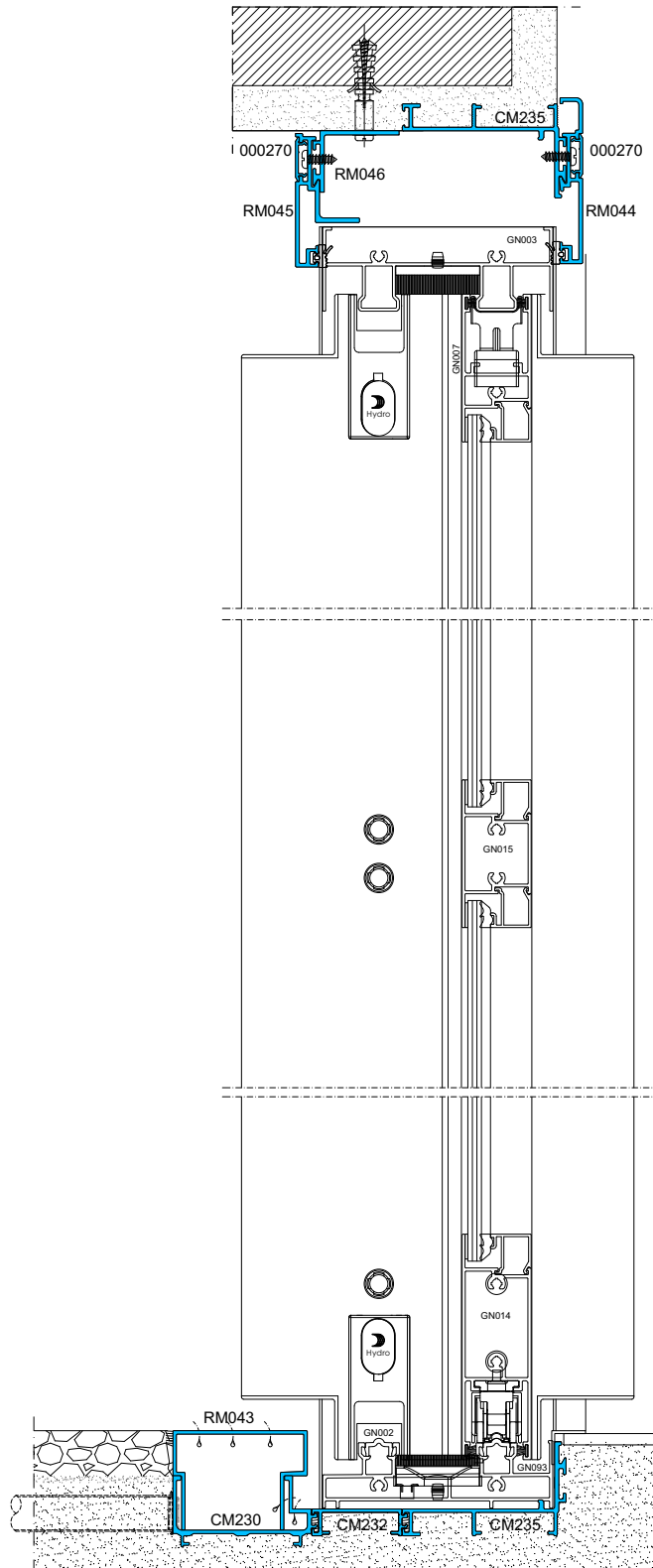

TIPOLOGIAS

Portas de Correr 2 e 4 folhas 2 planos

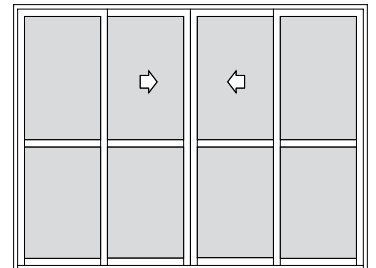
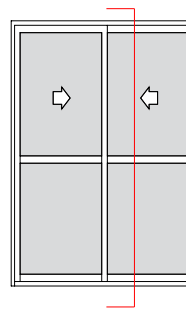

Aplicação no sistema Nova Gold



TIPOLOGIAS

Portas de Correr 3 folhas 3 planos

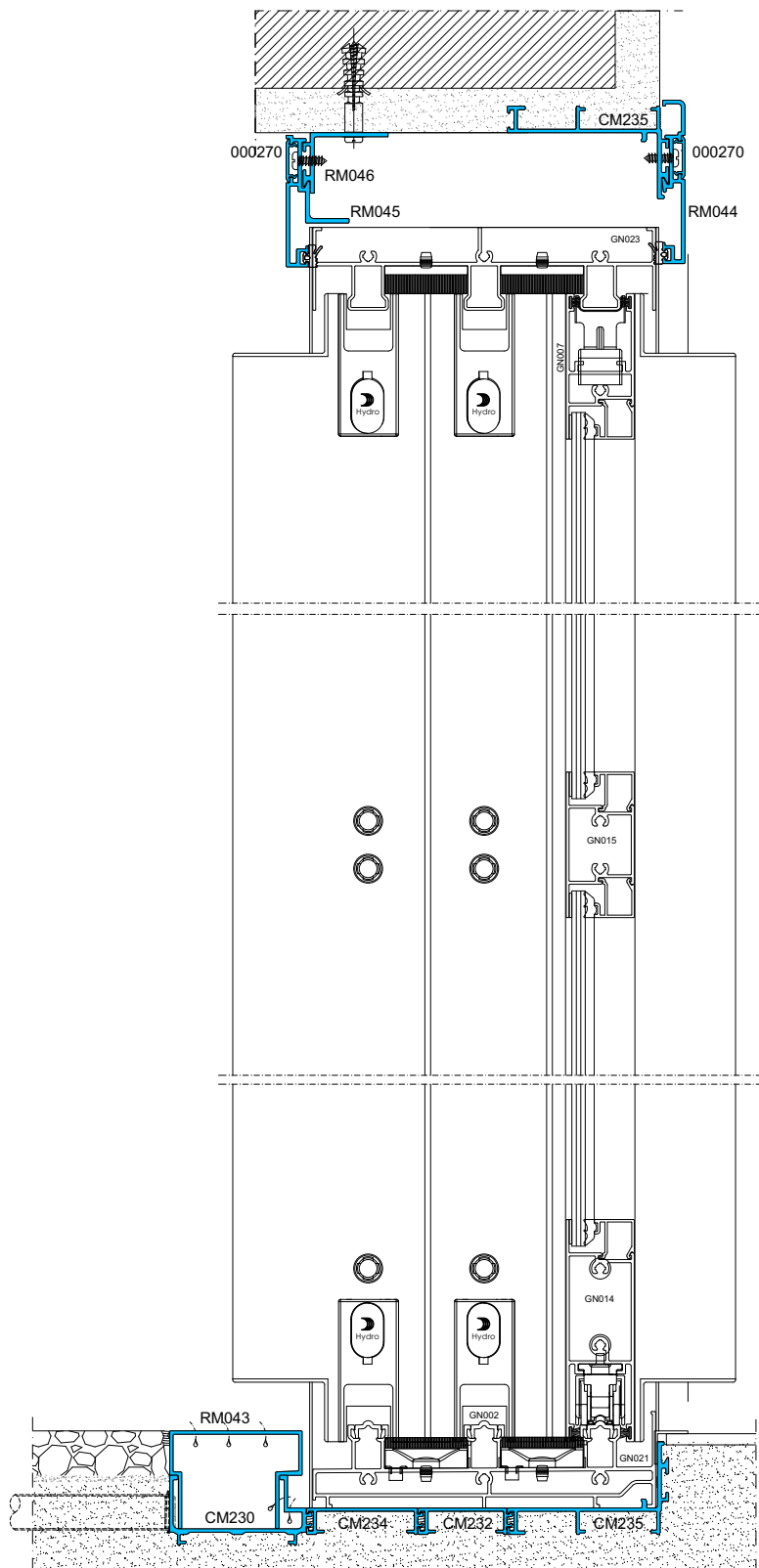
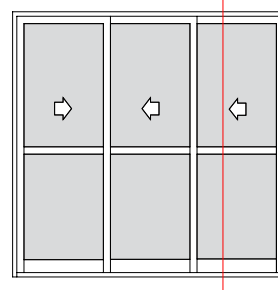

Aplicação no sistema Nova Gold



TIPOLOGIAS

Portas de Correr 4 folhas 4 planos

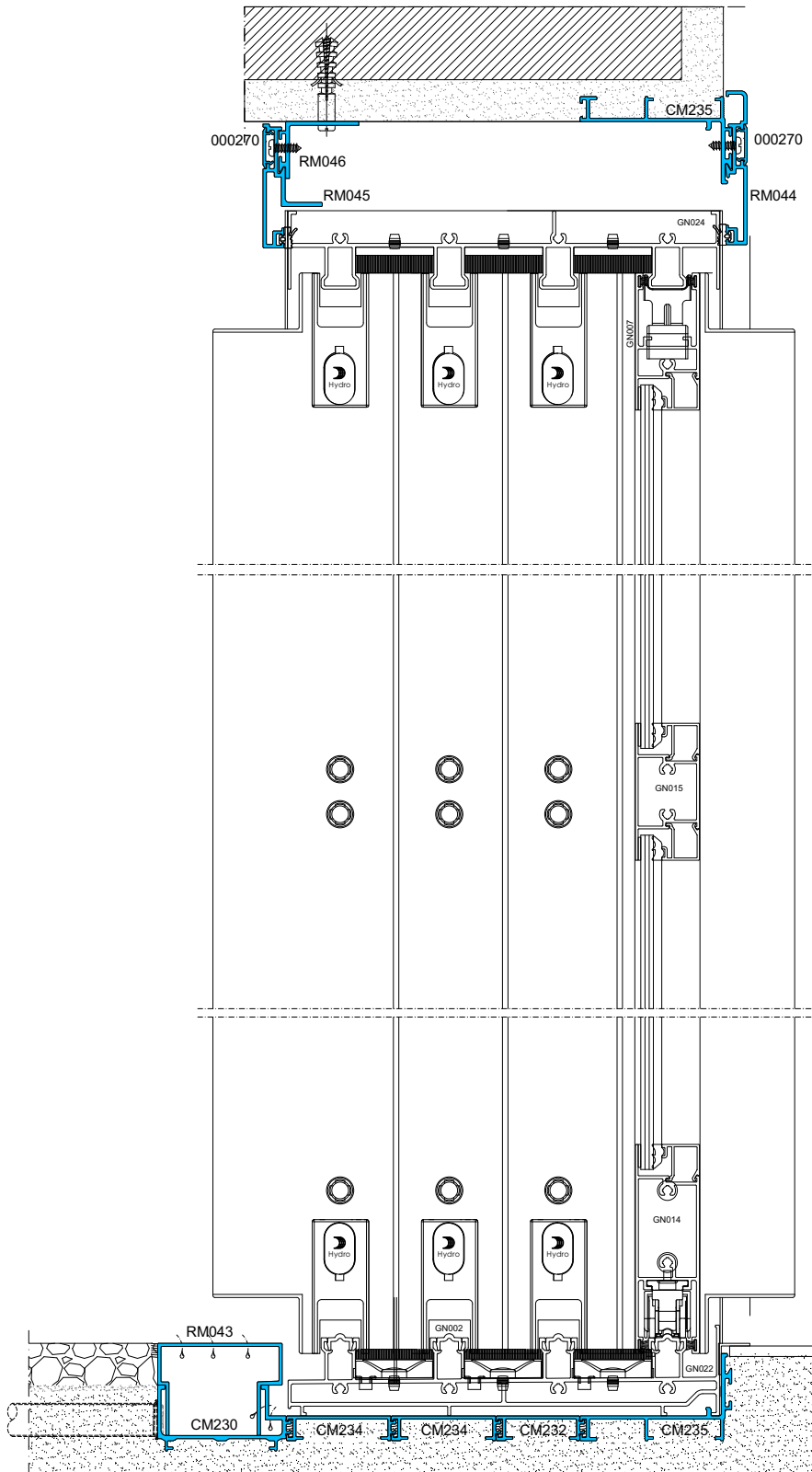
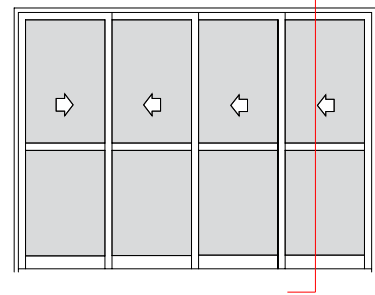

CM230 0,627 Kg/m
Contramarco da calha

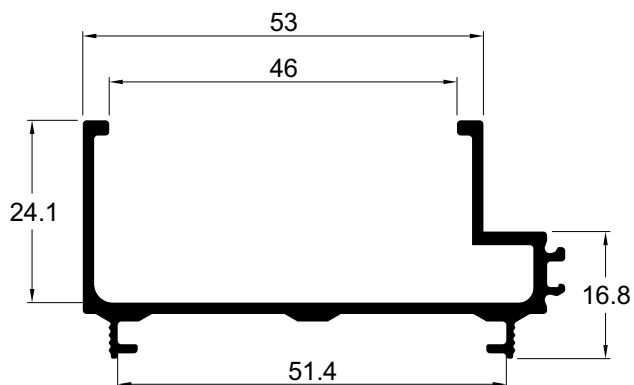

RM043 0,651 Kg/m
Tampa da calha

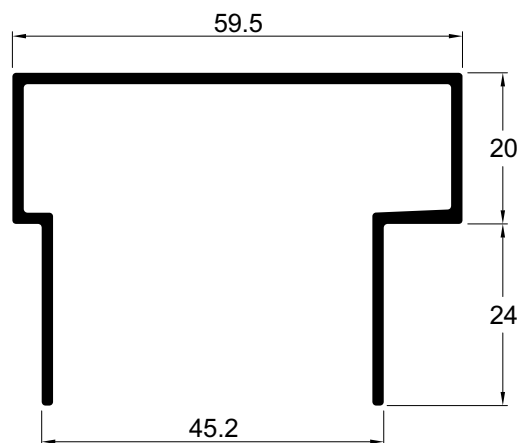

CM232 0,304 Kg/m
Complemento inferior da calha de 40

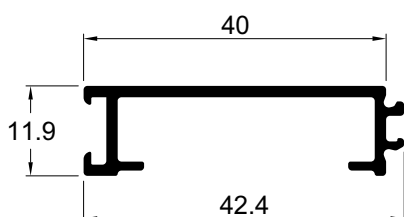

CM234 0,345 Kg/m
Complemento inferior da calha de 50

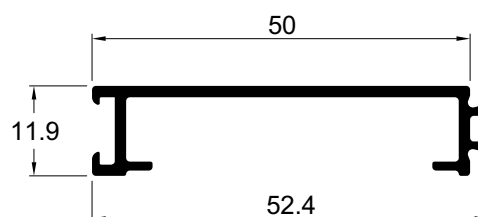

CM235 0,686 Kg/m
Contramarco inferior e superior da porta

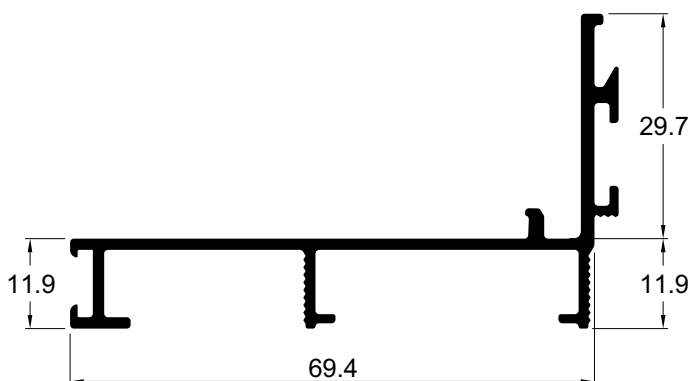

RM044 0,543 Kg/m

Arremate telescópico interno

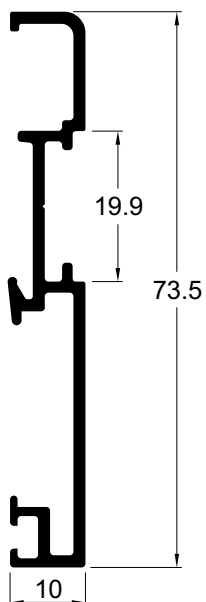

RM045 0,608 Kg/m

Arremate telescópico externo

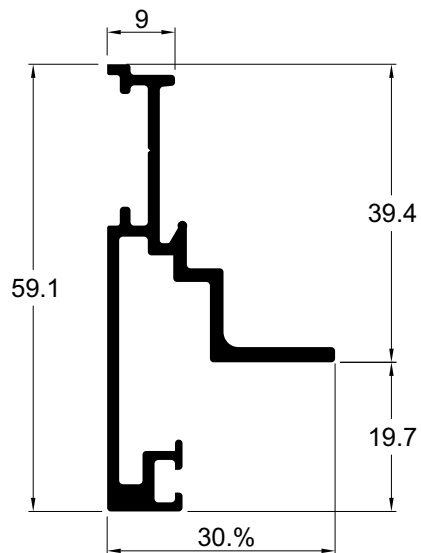

RM046 0,351 Kg/m

Suporte do arremate externo

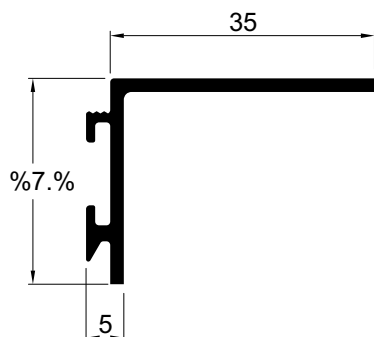

000270 0,081 Kg/m

Tampa do arremate

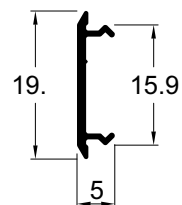



hydro.com/brasil



[@hydronobrasil](https://www.facebook.com/hydronobrasil)



[@hydronobrasil](https://www.instagram.com/hydronobrasil)



[Norsk Hydro](https://www.linkedin.com/company/Norsk-Hydro)



[hydronobrasil](https://www.youtube.com/hydronobrasil)